

<b>SensLights Model Specifications</b>	<b>SLL 1229M Occupancy Sensor</b>
Power Source	220-240V/AC <input checked="" type="checkbox"/>
Rated Load	1200W Max.tungsten ( $\cos\phi=1$ ) or 300W fluorescent ( $\cos\phi=0.5$ )
Transmission Power:	<0.2mW
Detection Angle	360 degrees
Detection Range	1 to < 20 m(radii.) (adjustable)
Tima Setting	8sec to 12min (adjustable)
Light-control	2~2000LUX (adjustable)
Measurement	9.6*4.2 CM
Weight	127g
Wiring	2IN / 2OUT
Installation Height	2.5~3.5m
Working temperature	-15°C~+70°C
HF system	5.8GHz CW Electric wave,ISM band
Illumination Location	Gate, backyard, garage, stairs, balcony, fence gate
Notes	1.Avoid sunshine or being against draft outlet of air-con and vent for the installation location. 2.Avoid humidity.



## SLL 1229M Occupancy sensor` SensLights

The microwave sensor is according to the microwave doppler effect <the basic principle of radar> , it can be widely used in as automatic control switch, the security system, and automatic video control system of ATM, as well as other automatic induction control area. The detection way has the below advantages compared with other as follows: 1. Non-contact detection, 2. Suitable for bad environment, immune to temperature, humidity, noise, air, dust, light ... 3. RF interference ability, 4. Transmission power only 0.2 mW, It will not harm the human body. Simple installation+ easy wiring. We use appropriate micro processing integrator, not only for high sensitivity and wide range of detection, and on very reliable work, error rate is extremely low, It can stable working on the temperature range: - 15 ~ + 70 Celsius degrees.



**NOTE:** the high-frequency output of this sensor is <0.2mW- that is just one 5000<sup>th</sup> of the transmission power of a mobile phone or the output of a microwave oven.

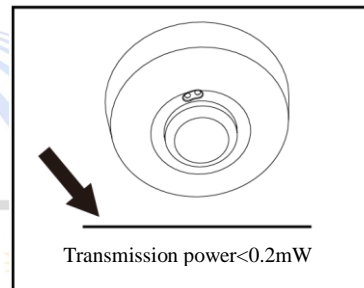

### SPECIFICATIONS:

Power source: 220-240V/AC   
Power frequency: 50/60Hz  
Transmission power: <0.2mW  
Rated load:  
1200W Max.tungsten(cosφ=1) (220-240V/AC)  
300W Max.fluorescent(cosφ=0.5) (220-240V/AC)

Installation sit: indoors, ceiling mounting  
Detection angle: 360°  
Detection range: 1-< 20m(radii.) (adjustable)  
Time setting: 8sec to 12min (adjustable)  
Light-control: 2~2000LUX (adjustable)  
Working temperature: -15°C~+70°C  
HF system: 5.8GHz CW Electric wave,ISM band  
Power consumption: approx.0.5W

### SENSOR INFORMATION:

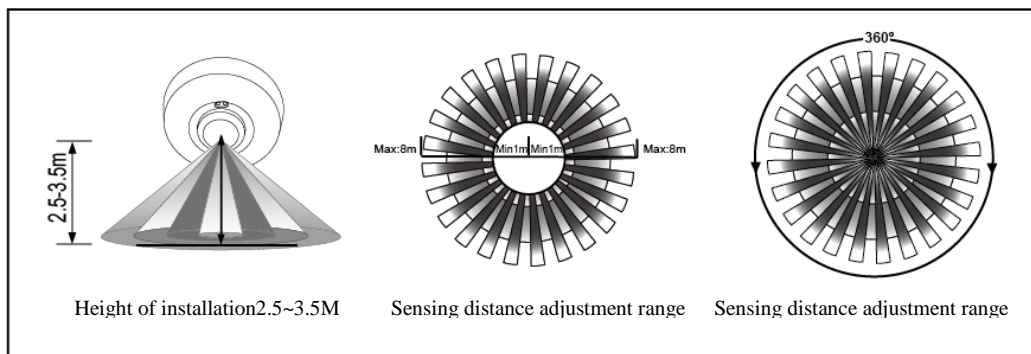

MULTITASKING CORPORATION



**INSTALLATION:**



**Warning!**

1. Please keep it away from the children.
2. Please avoid fire/high temperature/damp places for installation.
3. Please confirm when shut off the power cord access.

1. Take down the top cover by turning it anti-clockwise(see fig.1), and then tighten off the two screws fixing middle cover(see fig.2);
2. Hold base against the Ceiling and mark drill holes(see fig.3),paying attention to any existing wiring in the Ceiling;
3. Drill the holes, insert wall plugs (6mm dia.)(see fig.4);

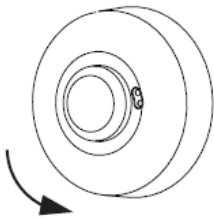

fig.1

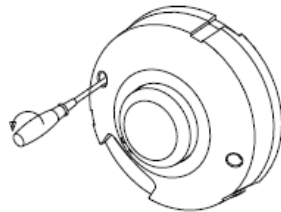

fig.2

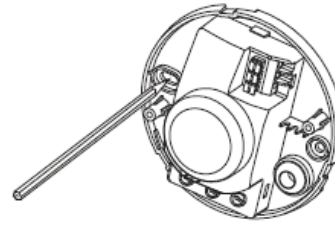

fig.3

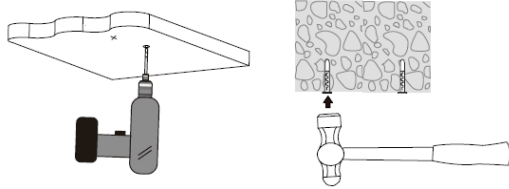

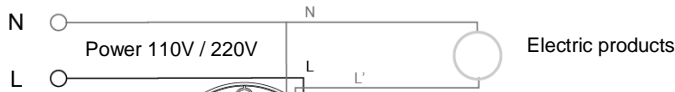

Fig.4

 When you are drilling ,please make sure you wear glasses and dust masks to prevent the dust fly into the nose and throat causing unnecessary trouble.

4. Put the power wire and load wire through the base holes(see fig.5);
5. Screw the base into place(see fig.6);
6. Connect the mains power supply and the load wire to the connection terminal according to connection-wire mark.
7. Close the middle cover(see fig.6) and adjust knob to setting;
8. Fit glass shade and turn it clockwise(see fig.6).



Connection illumination  
connect N, L with power;  
connect N, L' with load

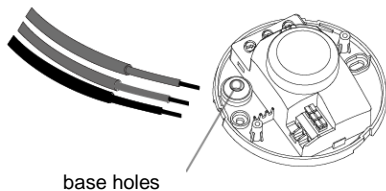

base holes

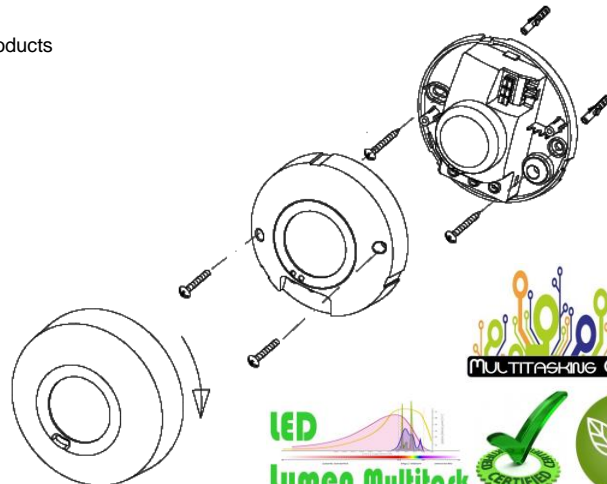
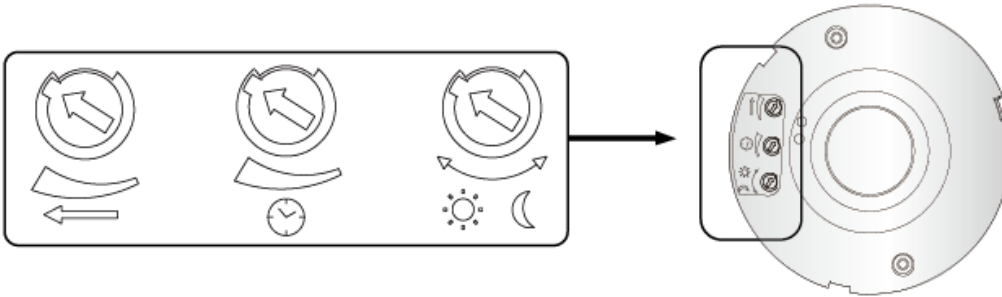
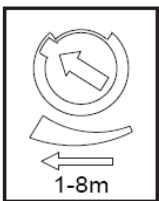

Fig.5

fig.6

**CONTROL KNOB:****Detection range setting (sensitivity)**

Detection range is the term used to describe the radii of the more or less circular detection zone produced on the ground after mounting the sensor light at a height of 2.5m, turn the Detection control fully anticlockwise to select minimum detection range (approx.1m radii), and fully clockwise to select maximum detection range (approx. <20 m radii).

**NOTE:** the above detection range is gained in the case of a person who is between 1.6m~1.7m tall with middle figure and moves at a speed of 1.0~1.5m/sec. if person's stature, figure and moving speed change, the detection range will also change.

**ATTENTION:**When use this product, please adjust the sensitivity to an appropriate position you need, please do not adjust the sensitivity to maximum, to avoid the product does not work normally caused by wrong motion. Because the sensitivity is too high easily detect the wrong motion by wind blowing leaves & curtains, small animals, and the wrong motion by interference of power grid & electrical equipment. All those lead the product does not work normally !

When the product does not work normally, please try to lower the sensitivity appropriately, and then test it.

WWW.SENSLIGHTS.COM

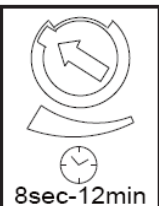
**Time setting**

Detection range is the term used to describe the radii of the more or less circular detection zone produced on the ground after mounting the sensor light at a height of 2.5m, turn the Detection control fully anticlockwise to select minimum detection range (approx.1m radii), and fully clockwise to select maximum detection range (approx. <20 m radii).

**NOTE:** after the light switches OFF, it takes approx. 1sec before it is able to start detecting movement again. The light will only switch on in response to movement once this period has elapsed.





### Light-control setting

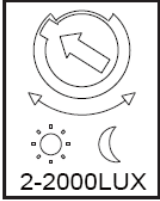

The chosen light response threshold can be infinitely from approx. 2-2000lux. Turn it fully anti-clockwise to select dusk- to-dawn operation at about 2 lux. Turn it fully clockwise to select daylight operation at about 2000lux. The knob must be turned fully clockwise when adjusting the detection zone and performing the walk test in daylight.

**Note: please don't adjust the three functional buttons to excess. That is because the three functional buttons were connected to the components directly, there is a small stopper in each of the three components, when you adjust the buttons from start to end, the excessive turn will damage the stopper, and lead to the 360° non-stop turn around. The adjust range limit is 270°, please do pay attention to this.**

### TROUBLESHOOTING:

Malfunction	Cause	Remedy
The load will not work	• wrong light-control setting selected	• Adjust setting
	• load faulty	• Change load
	• mains switch OFF	• Switch ON
The load work always	• continuous movement in the detection zone	• Check zone setting
The load work without any identifiable movement	• the sensor not mounted for detecting movement reliably	• Securely mount enclosure
	• movement occurred, but not identified by the sensor (movement behind wall, movement of a small object in immediate lamp vicinity etc.)	• Check zone setting
The load will not work despite movement	• rapid movements are being suppressed to minimize malfunctioning or the detection zone you have set is too small	• Check zone setting

### Warning!

Please confirm with professional installation.  
Please cut off power supply before installation and removal operations.  
Make sure that you have cut off the power for safety purposes.  
Improper operation caused losses, the manufacturer does not undertake any responsibility.

